

THE PROPERTY OF THE DRAWING IS ESTABLISHED BY LAW. IT IS FORBIDDEN TO PRODUCE OR SHOW IT TO THIRD PARTY, WITHOUT A WRITTEN AGREEMENT.

Item	Name	Q.ty
1	GR.6X8.Z	1
2	GVR.30.1	1
3	GVR.30.2	1
4	GVR.30.3	1
5	GVR.30.200	1
6	R.6.SCH	2
7	R.8.SCH	1
8	V.TCE6x35	2
9	V.TCE8x35	1

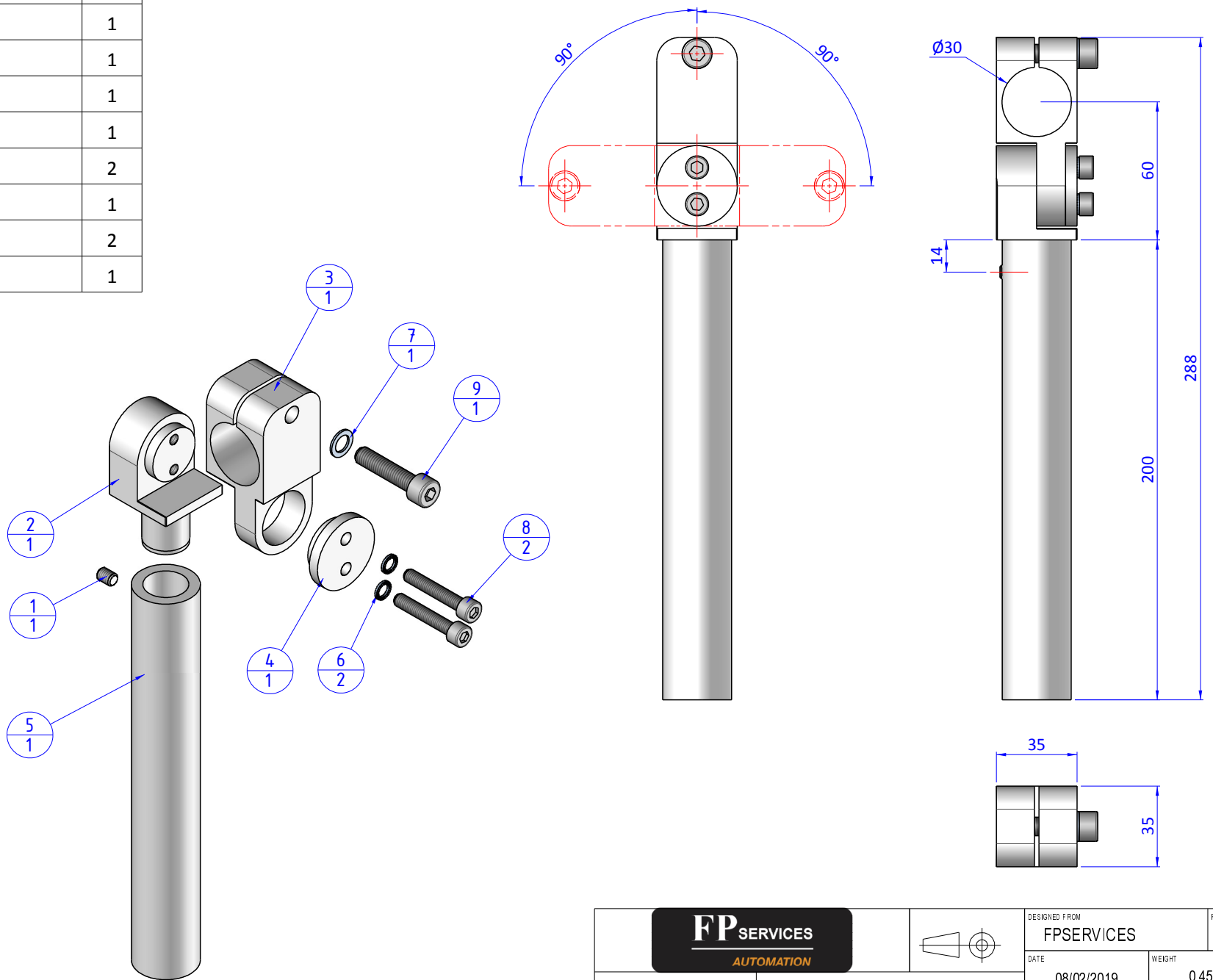

Format A3
UNI 936-76

		DESIGNED FROM		REVIEW
		FP SERVICES		A
GENERAL TOLERANCE		DATE	WEIGHT	
UNI - ISO 2768		08/02/2019	0,455kg	
CLASSE f		CODE		
		CA.GVR.3030.200		CA.GVR.3030.200